

MH134-5A



VIBRATION ANALYSIS HARDWARE

Hex Head Accelerometer Mounting Pad with Zerk Grease Fitting Adapter, 1/4-28 Tapped Hole, 1/8-27 NPT Mounting Thread



Product Features

Sensors can be magnet or stud mounted directly into Zerk grease fitting adapter

- ▶ Magnet mount or permanent mount accelerometers directly to top of Zerk adapter
- ▶ Zerk fitting included
- ▶ Stainless steel case material

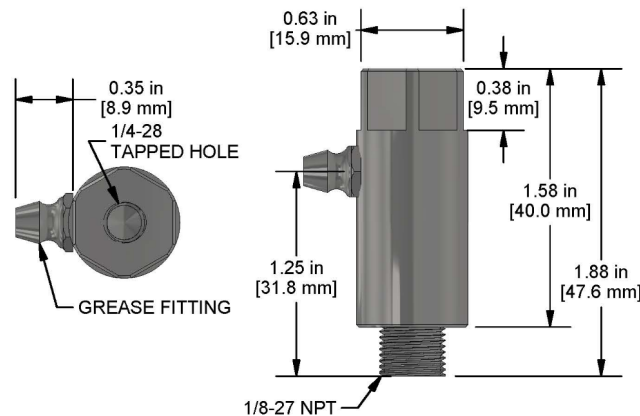

Specifications

Case Material	17-4 Stainless Steel
Dimensions	1.88 in (47.6 mm) x 0.63 in (15.9 mm)
Sensor Mounting	1/4-28 Mounting Hole
Field Mounting	1/8-27 NPT Adapter Mounting Thread

Chemical Compatibilities for Reference

- ▶ Gasoline - A
- ▶ Methanol - A
- ▶ Lubricants - A

Compatibility

- ▶ Compatible with any accelerometers with 1/4-28 stud or adapter
- ▶ Conversion mounting studs sold separately

Stock Product

Backed by our Unconditional Lifetime Warranty

www.ctconline.com | sales@ctconline.com | 585-924-5900