

TRIAxIAL WIRING INSTRUCTIONS

JB310 SERIES SWITCH BOX

1. Strip outer jacket of cable back 1¼ in. and remove all of the shielding.
2. Separate the internal wires from the shield and twist the shield drain wire.
3. Strip red, black, green, and white insulation back ¼ in.

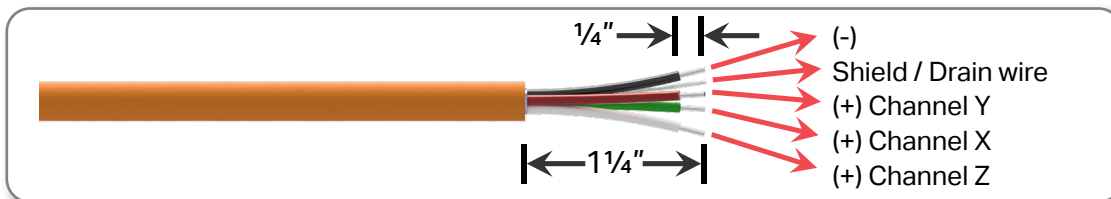

4. Locate the appropriate plug, identified by channel number, remove the plug and install the wires using a small flathead screwdriver. Push plug back into location

Orientation is as follows:

- a. Green insulated conductor wire (X) is connected to the first channel used.
- b. Red insulated conductor wire (Y) is connected to the second channel.
- c. White insulated conductor wire (Z) is connected to the third channel used.
- d. Black insulated conductor wire is connected to (-) and must be applied to each channel.
- e. Shield drain wire is connected to ground (GND) and needs only one termination.



[Visit our website](#) to download the full manual for JB310 enclosures.



TRIAxIAL WIRING INSTRUCTIONS

JB310 SERIES SWITCH BOX

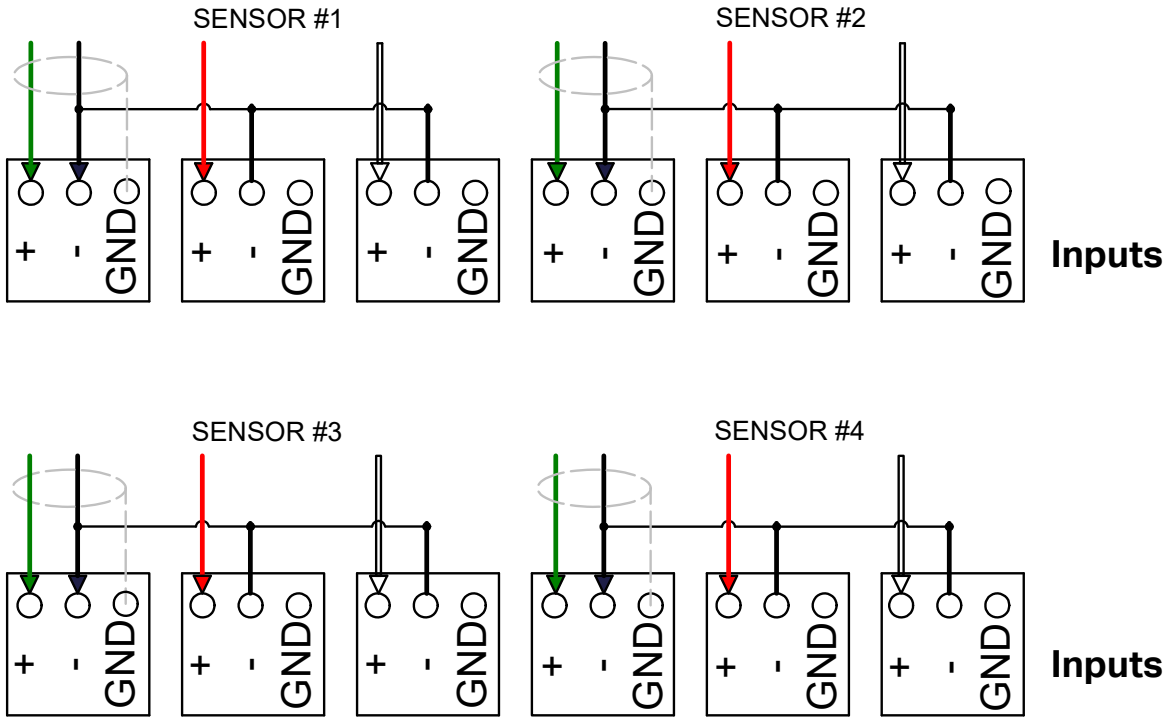

NOTE: COMMONS JUMPERED TOGETHER

Sensor Inputs

- Green = Positive X Axis
- Red = Positive Y Axis
- White = Positive Z Axis
- Black = Common
- Grey = Shield (Ground)

