

WIRING INSTRUCTIONS

DSB1003 SERIES MODULAR SWITCH BOX

1. Strip outer jacket of cable back 1¼ in. and remove all of the shielding.
2. Separate the internal wires from the shield and twist the shield drain wire.
3. Strip red and black insulation back ¼ in.

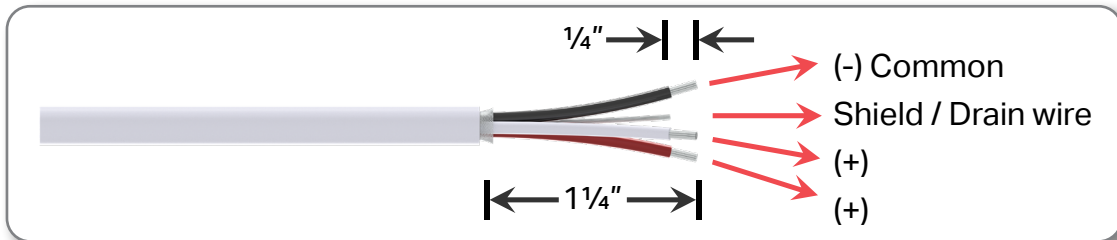

4. Locate the appropriate plug, identified by channel number, remove the plug and install the wires using a small flathead screwdriver. Push plug back into location. Refer to the chart on the next page for the correct orientation for your application.



[Visit our website](#) to download the full manual for DSB1003 enclosures.



WIRING INSTRUCTIONS

DSB1003 SERIES MODULAR SWITCH BOX

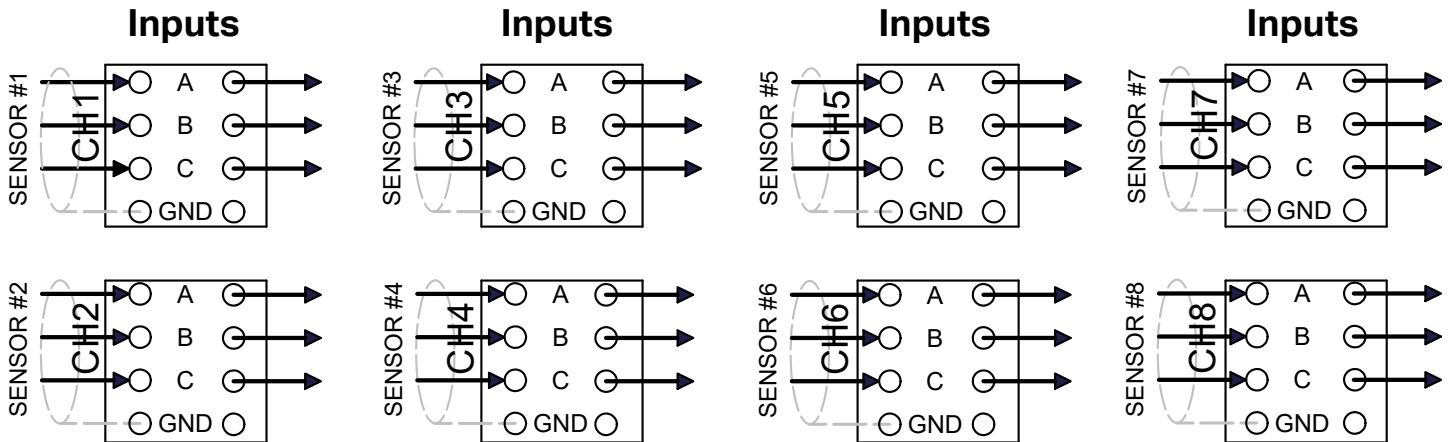

DUAL OUTPUT - VIBRATION & TEMPERATURE		
SOCKET A	RED WIRE	VIBRATION (+)
SOCKET B	BLACK WIRE	COMMON
SOCKET C	WHITE WIRE	TEMPERATURE (+)
SOCKET GND	SHIELD DRAIN	SHIELD

BIAXIAL VIBRATION - AXIS X & Z		
SOCKET A	GREEN WIRE	AXIS X (+)
SOCKET B	BLACK WIRE	COMMON
SOCKET C	WHITE WIRE	AXIS Z (+)
SOCKET GND	SHIELD DRAIN	SHIELD

TWO SINGLE AXIS VIBRATION		
SOCKET A	RED WIRE	SENSOR 1 (+)
SOCKET B	BLACK WIRE	COMMON
SOCKET C	RED WIRE	SENSOR 2 (+)
SOCKET GND	SHIELD DRAIN	SHIELD

LP400 SERIES DYNAMIC & 4-20 mA VIBRATION		
SOCKET A	WHITE WIRE	VIBRATION (+)
SOCKET B	BLACK WIRE	COMMON
SOCKET C	RED WIRE	4-20 mA (+)
SOCKET GND	SHIELD DRAIN	SHIELD



Note: CTC recommends using 4 conductor cables such as CB105, CB117, CB119, CB192, CB218, CB618, CB818, or CB819 for biaxial applications. If using a 3 conductor cable such as CB112, CB191, CB212, CB512, CB612, or CB812 substitute the red wire for green.