



VIBRATION ANALYSIS HARDWARE



4-20mA VIBRATION SENS
0-2 IPS, RMS
800-999-5290
585-924-5900
WWW.CTCONLINE.COM
Made in the USA



LP302-1R1-1E

SN: 1000



LP300 Series
Product Manual

TABLE OF CONTENTS

- Introduction.....3
- Product Specifications4
- Dimension Drawings4
- Wiring.....5
- Measurement6
- Installation7
- Warranty and Return Information 10



INTRODUCTION

4-20 mA Vibration Monitoring Process Overview

4-20 mA technology can be used to measure temperature, pressure, flow and speed, as well as the overall vibration of rotating machines. Adding a vibration sensor/transmitter to the machine provides a critical measure of the machine's health. It can be used to identify changes in balance, alignment, gears, bearings, and many other potential faults. The purpose of the 4-20 mA analog current loop is to transmit the signal from an analog vibration sensor over a distance in the form of a 4-20 mA current signal. The current signal generated is proportional to the overall vibration of the equipment or machinery that is being monitored. This output current has a range of 4-20 mA, with 4 representing the minimum and 20 representing maximum amplitudes (within the range of 4-20 mA). The 4-20 mA signal output is proportional to the overall amplitude generated within a defined frequency band. Therefore, the signal does not include data from frequencies outside the frequency band but includes all vibration (critical and non-critical faults) within that band.

LP300 Series Overview

LP300 series is a line of loop power vibration sensors measuring 4-20 mA proportional to vibration measured in acceleration.



PRODUCT SPECIFICATIONS

Power Input	15-30 Vdc supply voltage required
Band-Pass Filter	The vibration sensor contains a band-pass filter, consisting of a low-pass and a high-pass.
Analog Output	Full-scale output of 4-20 mA
Operation	Filters the signal, and normalizes the output to the specified full-scale output. Performs a true RMS conversion and transmits this data in a 4-20 mA format (if RMS is chosen).
Temperature Range	-40 °F to 185 °F (-40 °C to 85 °C)

DIMENSION DRAWINGS

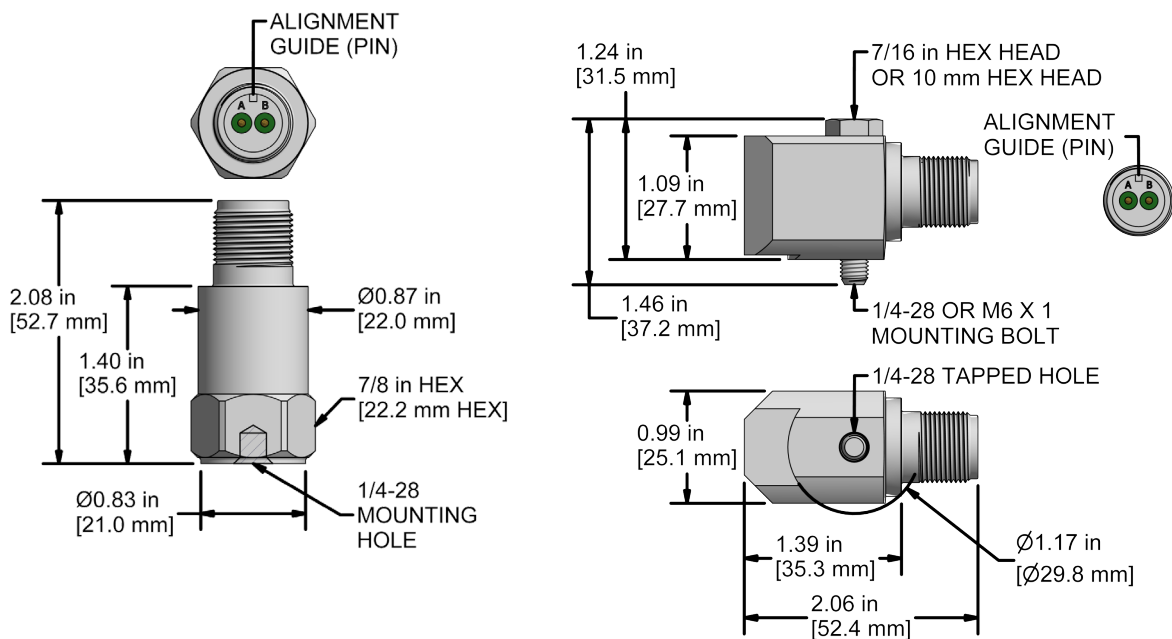

WIRING

Only two wires are required to send the current signal and also supply power to the sensor. A loop supply voltage is used to power the remote sensor. The remote sensor regulates the loop current such that the loop current represents the value of the parameter being measured by the sensor. A series resistor R_L at the loop power supply converts this current to a voltage that can be used by the process monitor/controller to record or distribute the parameter being measured.

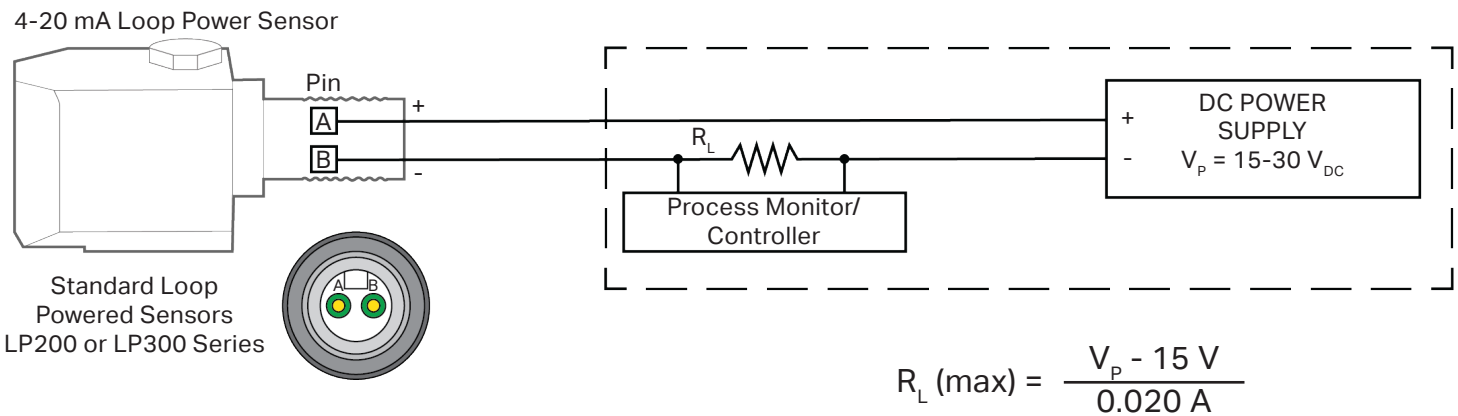

Loop Resistance Calculations

Standard Loop Powered Sensors

$$R_L (\text{max}) = \frac{V_p - 15 V \times (1 \text{ mA} / .001 A)}{20 \text{ mA}}$$

*Intrinsically Safe Loop Powered Sensors

$$R_L (\text{max}) = \frac{V_p - 12 V \times (1 \text{ mA} / .001 A)}{20 \text{ mA}}$$

*Note: Typical Loop Powered Circuit will include an Intrinsically Safe Barrier in the Circuit

Power Source Voltage (V_p)	Typical R_L (max) (Non-IS Sensors)	Typical R_L (max) (IS Sensors)
20	250	100
24	450	300
26	550	400
30	750	600

MEASUREMENT

FULL-SCALE MEASUREMENT RANGE	ACTUAL VIBRATION, IPS	EXPECTED OUTPUT (mA)
0 - 0.4 IPS (0 - 10 mm/s)	0	4
	0.1 (2.5 mm/s)	8
	0.2 (5.0 mm/s)	12
	0.3 (7.5 mm/s)	16
	0.4 (10.0 mm/s)	20
0 - 0.5 IPS	0	4
	0.1	7.2
	0.2	10.4
	0.3	13.6
	0.4	16.8
	0.5	20
0 - 0.8 IPS (0 - 20 mm/s)	0	4
	0.2 (5.0 mm/s)	8
	0.4 (10.0 mm/s)	12
	0.6 (15.0 mm/s)	16
	0.8 (20.0 mm/s)	20
0 - 1.0 g (LP300 Series)	0	4
	0.1	5.6
	0.25	8
	0.5	12
	0.75	16
	1	20
0 - 2.0 g (LP300 Series)	0	4
	0.25	6
	0.5	8
	0.75	10
	1	12
	1.25	14
	1.5	16
	1.75	18
	2	20



INSTALLATION

Hand tighten the sensor to the mounting disk and tighten using **2 to 5 ft-lbs of mounting force**.

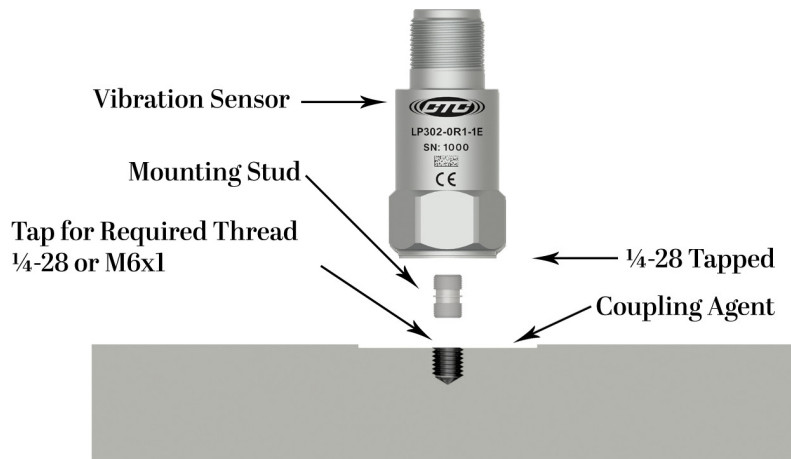

- The mounting torque is important to the frequency response of the sensor for the following reasons:
 - If the sensor is not tight enough, proper coupling between the base of the sensor and the mounting disk will not be achieved.
 - If the sensor is over tightened, stud failure may occur.
- A coupling agent (such as MH109-3D epoxy) will maximize the high frequency response of your hardware, but is not required.

Permanent/Stud Mounting Surface Preparation

Prepare flat surface using a spot face tool and pilot drill hole using a CTC spot face installation tool.

The mounting surface should be clean and free from any residue or paint.

Tap for required thread (1/4 - 28 or M6x1).

Install sensor.

- Suggested Installation Tool Kit: MH117-1B



Adhesive Mounting Installation

Ensure mounting surface is clean and free from any residue or paint to ensure proper bonding of the adhesive.

A smooth, flat mounting surface is desirable, and can be achieved by milling or grinding at the surface where the mounting stud is to be installed.

Place a small portion of adhesive on the underside of the mounting base.

Firmly press down the mounting disk to mounting area to force the adhesive out from under the disk.

Hold disk onto surface until the adhesive can support the weight of the mounting disk, ensuring the disk does not move or slide on the adhesive.

Allow for adhesive to fully cure.

Install sensor.

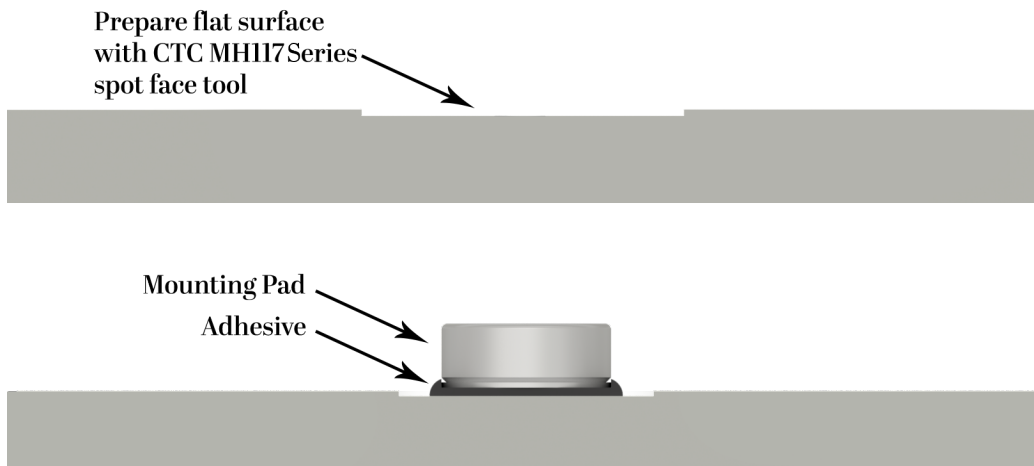

Motor Fin Mount Probe/Pad Installation

Prepare cooling fins on motor for mounting by scraping or grinding any paint or debris between cooling fins.

Clean mounting area with a non-residue spray degreaser that will not leave a thin film lubricating residue.

Mix adhesive.

Apply adhesive to the sides and the bottom of the probe portion of the motor fin mount probe/pad (please note: the area is intentionally roughened to enhance the bonding area).

Place the motor fin mount probe/pad between the motor fins at the desired location.

- The probe must fit in between the motor fins and the bottom of the probe must contact the motor casing.
- For motors that have a space greater than ½ in. between each fin, motor fin mount probe pads with a thickness of ½ in. are available and will reduce the amount of adhesive needed.

Firmly press the motor fin mount probe/pad into place, ensuring the bottom of the motor fin mount probe/pad is touching the motor casing (this contact area is where the vibration is transferred from the motor to the sensor).

- The tip of the motor fin mount probe/pad should be as flat against the motor casing as possible (See left side of figure below).
- **The motor fin mount probe/pad should not be resting on the top of the fins – if it does, then the bottom of the probe may not be in direct contact with the motor casing** (See right side of figure below).

Use a spatula to redirect any epoxy that has been displaced from the mounting area when pushing the fin mount probe/pad into place.

Fill in any remaining voids with adhesive to ensure the motor fin will be fixed in place.

Allow for adhesive to fully cure.

Install sensor.

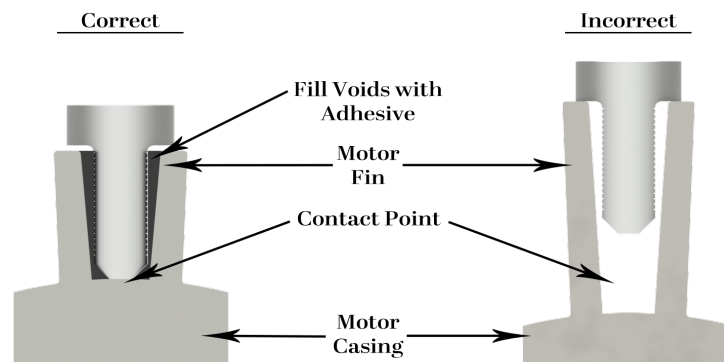

WARRANTY AND REFUND

Warranty

All CTC products are backed by our unconditional lifetime warranty. If any CTC product should ever fail, we will repair or replace it at no charge.

Refund

All stock products can be returned for a 25% restocking fee if returned in new condition within 90 days of shipment. Stock products qualify for free cancellation if your order is cancelled within 24 hours of purchase. Built-to-order products qualify for a 50% refund if returned in new condition within 90 days of shipment. Custom products are quoted and built specifically to the requirements of the customer, which may include completely custom product designs or private labeled versions of standard products for OEM customers. Custom products ordered are non-cancellable, non-returnable and non-refundable.

